

QLSP14RGB\_B  
(2121 PLCC 4 LED)



## Product Outline:

This is the small TOP LED with 3 color (Red/Green/Blue) combined in one package. This special package is ideal for customer's application in traffic signal and sign boards on production promotion. With special binning technology, Quelighting is able to provide special binning for customer's needs

## Features:

- 3 colors(Red/Green/Blue) LED Package
- High brightness output @ 20mA,
- Package Dimension = 2.1mm x 2.1mm x 2.0mm
- RoHS compliant
- Custom Bin available upon special request
- View angel >120°

## Application:

- Architecture Lighting
- Sign board backlighting
- Emergency vehicle lighting
- Traffic signal lighting
- Automotive lighting

## Compliance and Certification:



**Mechanical Property:  
(Dimension)**

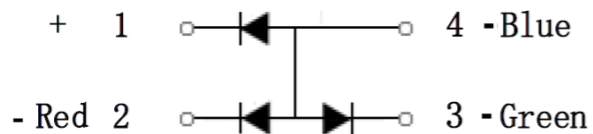
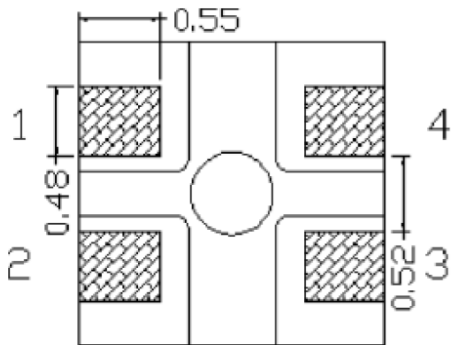
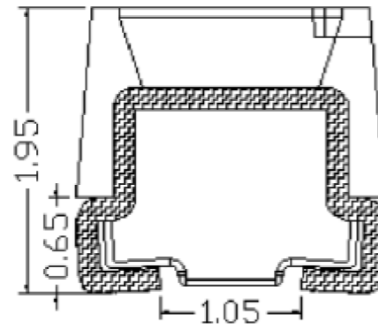
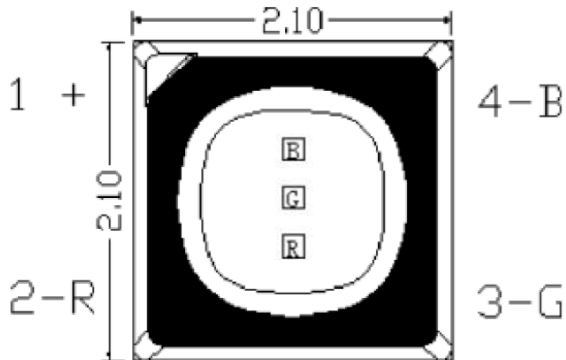

\* All dimensions are in millimeters, \* Tolerances are  $\pm 0.10$ mm.

**Recommended Solder footprint:**

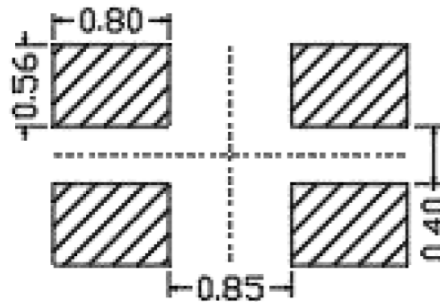

- \* All dimensions are measured in mm
- \* The LEDs is designed to be reflow soldered on to a PCB. IF dip soldered that QL cannot guarantee its reliability.
- \* Reflow soldering must not be performed more than twice.



# Characteristics

## ■ Absolute Maximum Ratings

(Ta=25°C)

Parameter	Symbol	Rating	Unit
DC Forward Current <b>RGB</b>	$I_f$	20	mA
Power Dissipation	$P_d$ (R)	90	mW
	$P_d$ (G)	100	
	$P_d$ (B)	100	
Pulse Forward Current ( <b>RGB</b> )	$I_{fp}$	100	mA
Storage Temperature	$T_{st}$	-40 ~ +100	°C
Operation Temperature	$T_{op}$	-40 ~ +85	°C
Soldering Temperature	$T_{sol}$	260 < 10 sec	°C

- (1) Proper current rating must be observed to maintain junction temperature below maximum at all time  
 (2) IFP Condition: Duty 1/10, Pulse within 10msec



**■ Electrical / Optical Characteristic @20mA** (Ta=25 °C)

Parameter	Symbol	Condition	Min.	Typ.	Max.	Unit
Luminous Intensity	I <sub>v</sub>	R	700		1000	mcd
		G	1800		2200	
		B	400		600	
Forward Voltage	V <sub>f</sub>	R	2.0		2.4	V
		G	2.9		3.4	
		B	3.0		3.4	
Reverse Voltage	V <sub>R</sub>				5	V
Reverse Current	I <sub>R</sub>				5	μA
Dominant Wavelength	λ <sub>d</sub>	R	620		625	nm
		G	520		525	
		B	465		470	
View Angle	θ			120		deg

- (1) Tolerance of measurement (luminous intensity): ±15%
- (2) Tolerance of Forward Voltage : ±0.05V
- (3) Tolerance of Peak emission wavelength: ±1.0nm



■ Color Bin Code:

色区	Bin	MinIv	MaxIv	x1	y1	x2	y2	x3	y3	x4	y4	MinVF	MaxVF	MinVF	MaxVF	MinVF	MaxVF
A1	1	2500	2800	0.2467	0.2551	0.2486	0.2676	0.2623	0.2655	0.2606	0.253	2.1	2.2	2.9	3.0	2.9	3.0
	2	2500	2800	0.2467	0.2551	0.2486	0.2676	0.2623	0.2655	0.2606	0.253	2.1	2.2	2.9	3.0	2.9	3.0
A2	3	2500	2800	0.2486	0.2676	0.2504	0.2801	0.2643	0.278	0.2625	0.2655	2.1	2.2	2.9	3.0	2.9	3.0
	4	2500	2800	0.2486	0.2676	0.2504	0.2801	0.2643	0.278	0.2625	0.2655	2.1	2.2	2.9	3.0	2.9	3.0
A3	5	2500	2800	0.2504	0.2801	0.2523	0.2926	0.2662	0.2905	0.2643	0.278	2.1	2.2	2.9	3.0	2.9	3.0
	6	2500	2800	0.2504	0.2801	0.2523	0.2926	0.2662	0.2905	0.2643	0.278	2.1	2.2	2.9	3.0	2.9	3.0
A4	7	2500	2800	0.2523	0.2926	0.2542	0.3051	0.2681	0.303	0.2662	0.2905	2.1	2.2	2.9	3.0	2.9	3.0
	8	2500	2800	0.2523	0.2926	0.2542	0.3051	0.2681	0.303	0.2662	0.2905	2.1	2.2	2.9	3.0	2.9	3.0
A5	9	2500	2800	0.2542	0.3051	0.2561	0.3176	0.27	0.3155	0.2681	0.303	2.1	2.2	2.9	3.0	2.9	3.0
	10	2500	2800	0.2542	0.3051	0.2561	0.3176	0.27	0.3155	0.2681	0.303	2.1	2.2	2.9	3.0	2.9	3.0
B1	11	2500	2800	0.2606	0.253	0.2625	0.2655	0.2764	0.2634	0.2745	0.2509	2.1	2.2	2.9	3.0	2.9	3.0
	12	2500	2800	0.2606	0.253	0.2625	0.2655	0.2764	0.2634	0.2745	0.2509	2.1	2.2	2.9	3.0	2.9	3.0
B2	13	2500	2800	0.2625	0.2655	0.2643	0.278	0.2782	0.2759	0.2764	0.2634	2.1	2.2	2.9	3.0	2.9	3.0
	14	2500	2800	0.2625	0.2655	0.2643	0.278	0.2782	0.2759	0.2764	0.2634	2.1	2.2	2.9	3.0	2.9	3.0
B3	15	2500	2800	0.2643	0.278	0.2662	0.2905	0.2801	0.2884	0.2762	0.2759	2.1	2.2	2.9	3.0	2.9	3.0
	16	2500	2800	0.2643	0.278	0.2662	0.2905	0.2801	0.2884	0.2762	0.2759	2.1	2.2	2.9	3.0	2.9	3.0
B4	17	2500	2800	0.2662	0.2905	0.2681	0.303	0.282	0.3009	0.2801	0.2884	2.1	2.2	2.9	3.0	2.9	3.0
	18	2500	2800	0.2662	0.2905	0.2681	0.303	0.282	0.3009	0.2801	0.2884	2.1	2.2	2.9	3.0	2.9	3.0
B5	19	2500	2800	0.2681	0.303	0.27	0.3155	0.2839	0.3134	0.282	0.3009	2.1	2.2	2.9	3.0	2.9	3.0
	20	2500	2800	0.2681	0.303	0.27	0.3155	0.2839	0.3134	0.282	0.3009	2.1	2.2	2.9	3.0	2.9	3.0
C1	21	2500	2800	0.2745	0.2509	0.2764	0.2634	0.2903	0.2613	0.2884	0.2488	2.1	2.2	2.9	3.0	2.9	3.0
	22	2500	2800	0.2745	0.2509	0.2764	0.2634	0.2903	0.2613	0.2884	0.2488	2.1	2.2	2.9	3.0	2.9	3.0
C2	23	2500	2800	0.2764	0.2634	0.2782	0.2759	0.2921	0.2738	0.2903	0.2613	2.1	2.2	2.9	3.0	2.9	3.0
	24	2500	2800	0.2764	0.2634	0.2782	0.2759	0.2921	0.2738	0.2903	0.2613	2.1	2.2	2.9	3.0	2.9	3.0
C3	25	2500	2800	0.2782	0.2759	0.2801	0.2884	0.294	0.2863	0.2921	0.2738	2.1	2.2	2.9	3.0	2.9	3.0
	26	2500	2800	0.2782	0.2759	0.2801	0.2884	0.294	0.2863	0.2921	0.2738	2.1	2.2	2.9	3.0	2.9	3.0
C4	27	2500	2800	0.2801	0.2884	0.282	0.3009	0.2959	0.2988	0.294	0.2863	2.1	2.2	2.9	3.0	2.9	3.0
	28	2500	2800	0.2801	0.2884	0.282	0.3009	0.2959	0.2988	0.294	0.2863	2.1	2.2	2.9	3.0	2.9	3.0
C5	29	2500	2800	0.282	0.3009	0.2839	0.3134	0.2978	0.3113	0.2959	0.2988	2.1	2.2	2.9	3.0	2.9	3.0
	30	2500	2800	0.282	0.3009	0.2839	0.3134	0.2978	0.3113	0.2959	0.2988	2.1	2.2	2.9	3.0	2.9	3.0

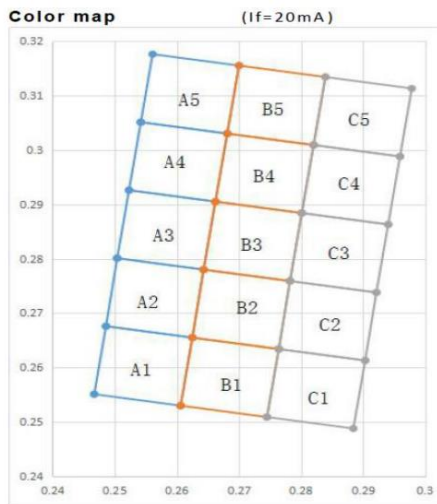

\*Tolerance = +/- 10%



## Characteristic Curves

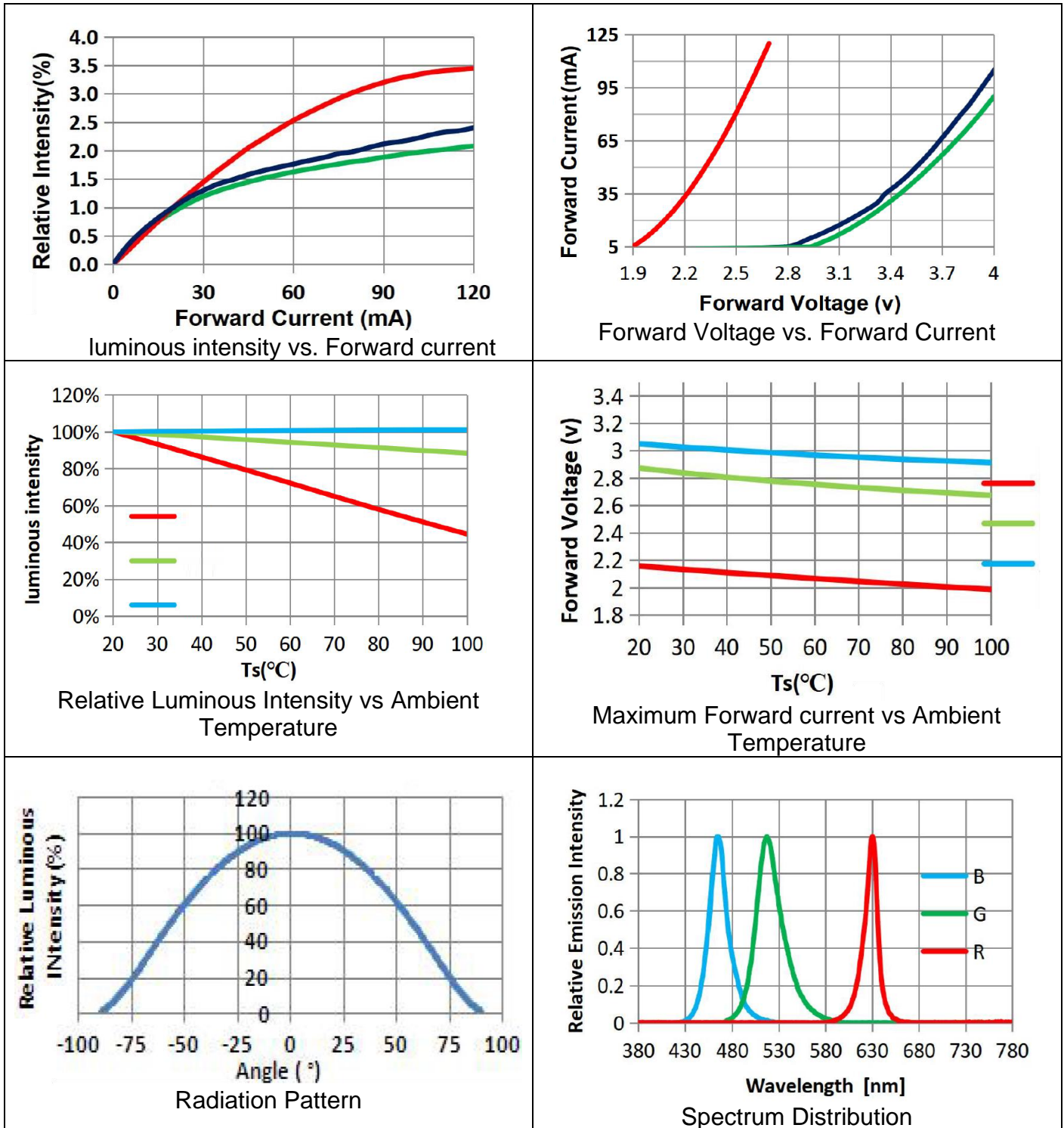



## ■ Reliability test:

No	Item	Condition	Time/Cycle	Sample size
1	Steady State Operating Life of Room Temperature	25°C Operating	1000 Hrs	20 pcs
2	Steady State Operating Life of Low Temperature -40°C	-40°C Operating	1000 Hrs	20 pcs
3	Steady State Operating Life of Low Temperature 60°C	60°C Operating	1000 Hrs	20 pcs
4	Steady State Operating Life of Low Temperature 85°C	85°C Operating	1000 Hrs	20 pcs
5	Low temperature storage -40°C	-40°C Storage	1000 Hrs	20 pcs
6	High temperature storage 100°C	100°C Storage	1000 Hrs	20 pcs
7	Steady State Operating Life of High Humidity Heat 60°C 90%	60°C/90% Operating	1000 Hrs	20 pcs
8	Steady State Pulse Operating Life Condition	25°C 10Hz duty=1/10 Operating	200 Cycle	20 pcs
9	Resistance to soldering heat on PCB (JEDEC MSL3)	pre-store@60°C, 60%RH for 52hrs Tslid max.=260 10sec	3 Times	20 pcs
10	Heat Cycle Test (JEDEC MRC)	25°C~65°C~-10°C, 90%RH, 24hr/1cycle	10 Cycle	20 pcs
11	Thermal shock	-40°C/ 20minr~ 5minr~100°C /20min	100 Cycle	20 pcs

## ■ Judgment Criteria:

Item	Symbol	Test Condition	Judgment Criteria
Forward Voltage	Vf	20 mA	$\Delta Vf < 10\%$





■ **Solder Profile:**

-The recommended reflow soldering profile is as follows (temperatures indicated are as measured on the surface of the LED resin):

Reflow Soldering Profile For Lead-free SMT Process.

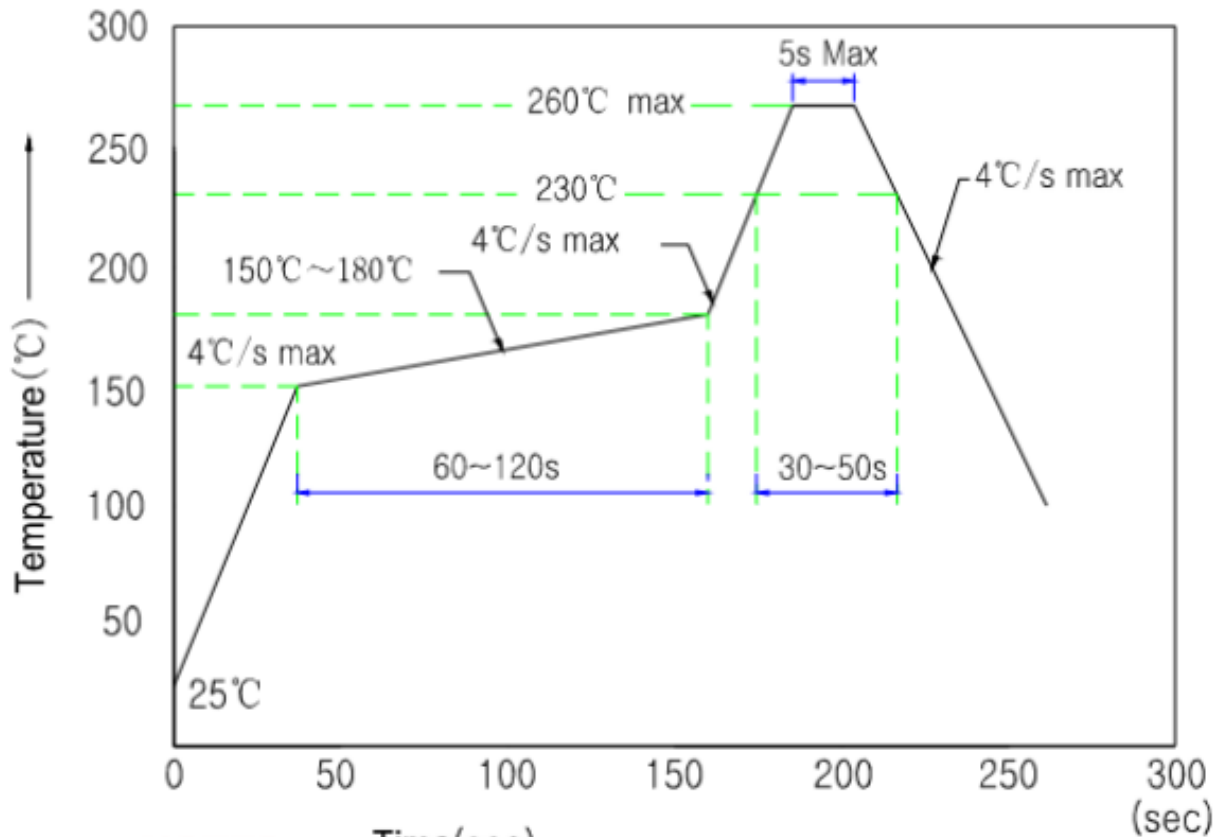

**NOTES:** Time(sec) →

1. We recommend the reflow temperature 245°C (+/-5°C). The maximum soldering temperature should be limited to 260°C.
2. Don't cause stress to the epoxy resin while it is exposed to high temperature.
3. Number of reflow process shall be 2 times or less.



■ Taping & Packing:

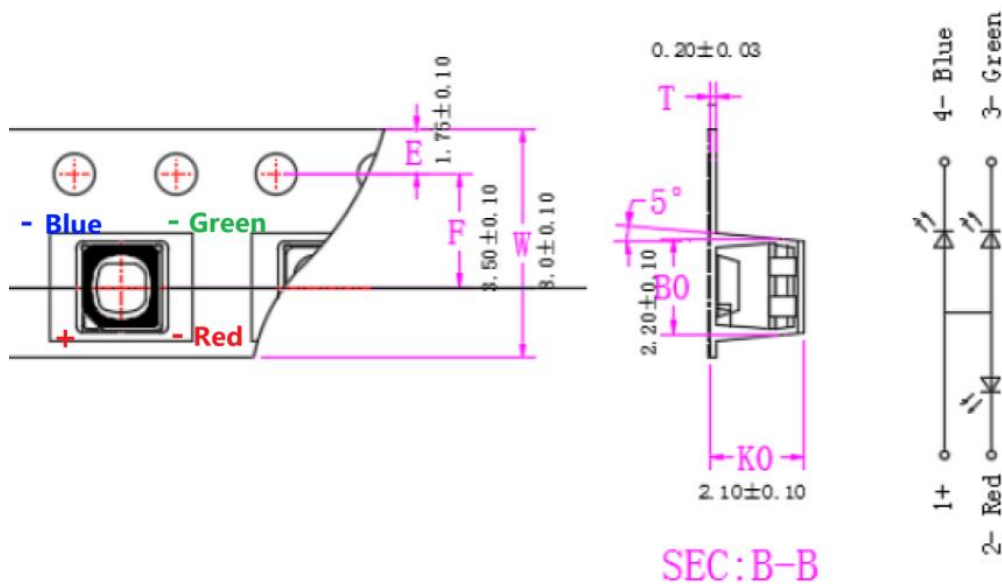
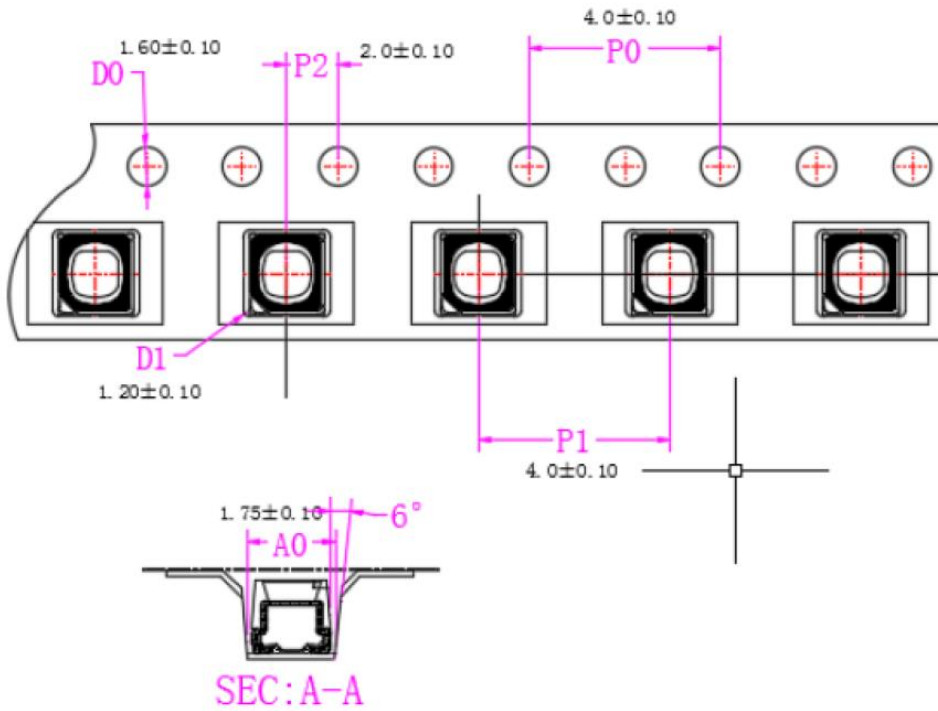

Unit : mm



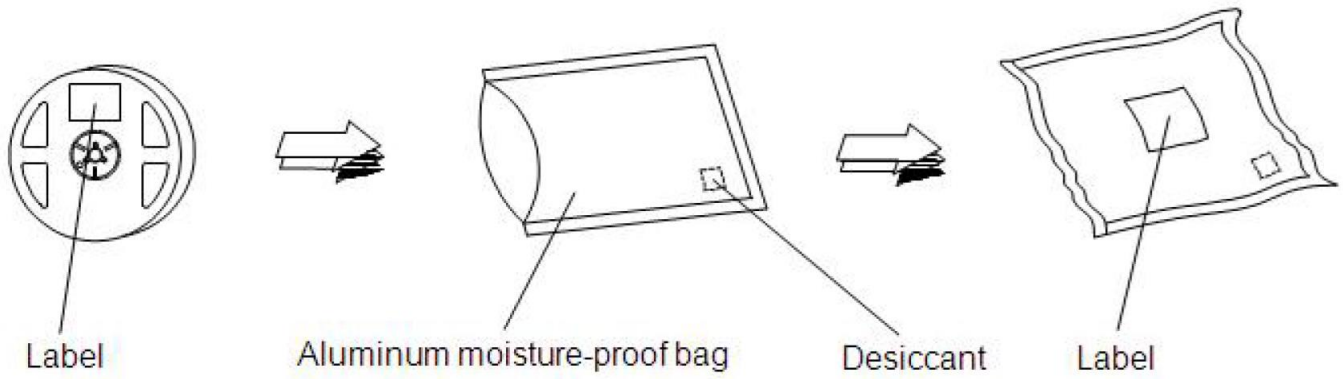
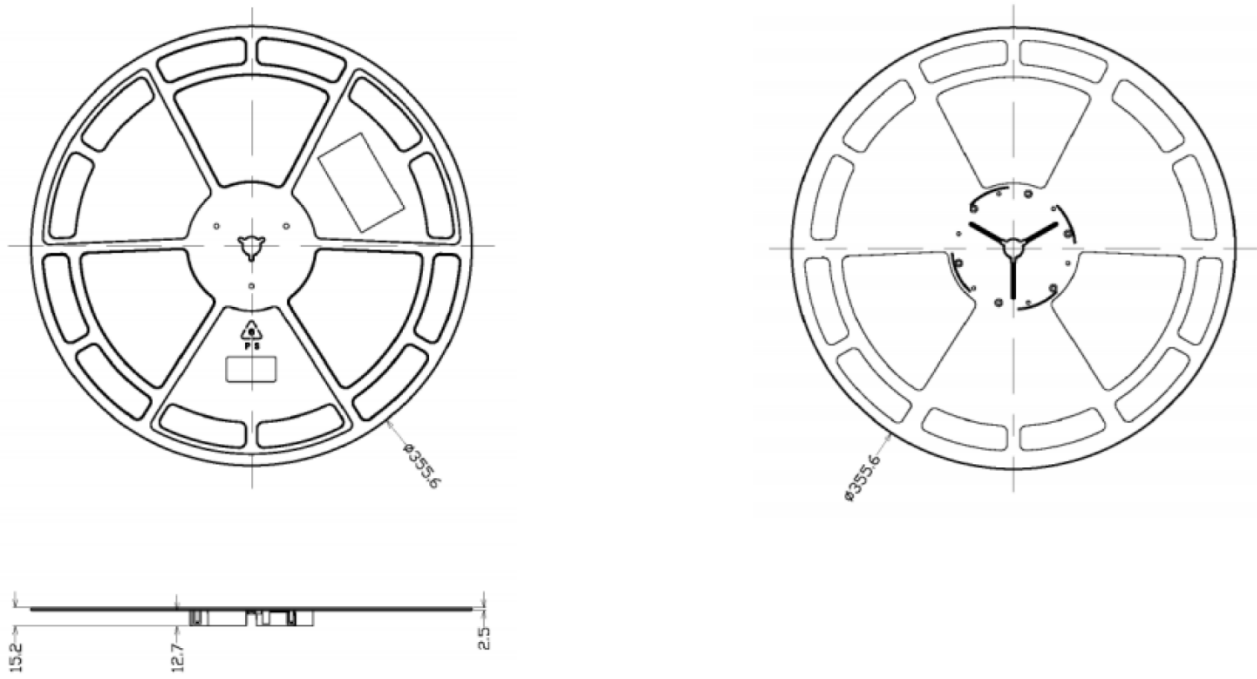



Unit : mm



## ■ Labeling





Quantity: XXXX



Quelighting P/N: XXXXXX



Lot number: XXXXX

Iv Bin: XX
Color Bin: XX
Vf Bin: XX
Date Code: XXXX

## ■ Ordering Information:

Part #	Multiple Quantities	Quantity per Reel
QLSP14RGB_B PLCC 4	Sampling stage	4,000 pcs
	MP stage	10,000 pcs



**■ Revision History:**

<b>Revision Date:</b>	<b>Changes:</b>	<b>Version #:</b>
04-20-2021	Initial release	1.0
5-12-2021	Added 4k reel	1.1
5/10/2022	Revise bin structure	1.2
7/12/2022	Added 10k reel for MP	1.3
2/16/2023	Revised solder foot print.	1.4
4/11/2023	Revised TR polarity chart	1.5
10/22/2024	- Revised mechanical property chart and TR chart	1.6

